

# **Two-Tier Haddon Matrix Approach to Fault Analysis of Accidents and Cybernetic Search for Relationship to Effect Operational Control: A Case Study at a Large Construction Site**

**Atmadeep Mazumdar**

Department of Production Engineering, Jadavpur University, Kolkata, India

**Krishna Nirmalya Sen**

Larsen & Toubro, Mumbai, India

**Balendra Nath Lahiri**

Department of Production Engineering, Jadavpur University, Kolkata, India

*The Haddon matrix is a potential tool for recognizing hazards in any operating engineering system. This paper presents a case study of operational hazards at a large construction site. The fish bone structure helps to visualize and relate the chain of events, which led to the failure of the system. The two-tier Haddon matrix approach helps to analyze the problem and subsequently prescribes preventive steps. The cybernetic approach has been undertaken to establish the relationship among event variables and to identify the ones with most potential. Those event variables in this case study, based on the cybernetic concepts like control responsiveness and controllability salience, are (a) uncontrolled swing of sheet contributing to energy, (b) slippage of sheet from anchor, (c) restricted longitudinal and transverse swing or rotation about the suspension, (d) guilt or uncertainty of the crane driver, (e) safe working practices and environment.*

hazard Haddon matrix fault analysis accident analysis cybernetics

---

## **1. INTRODUCTION**

Recent accomplishments of the manufacturing systems, advanced weapon systems, rail transit systems, advanced aircraft systems, and computer developments for command and control systems have all shown the need for a better understanding of their advanced state-of-the-art inbuilt in those systems. Nonetheless, inherent in the basic use of these systems is the recognition of the hazards and

their identification. With modern improvements in science and technology there is a constant need to learn about hazards and ways of controlling them. For a production engineer knowledge of safety and hazard identification management, and a disciplined program of hazard control are a must.

A hazard identification process requires a formalized method of analyzing the product or the system. This new organizational development has necessitated an introduction of a new system

methodology in the conceptual domain of “system safety”, which is now established as a formal, disciplined approach to hazard management. Relevant terminologies, e.g., hazard, system, stimulus, accident, safety, and risk are available and explained in standard texts [1].

Accidents and injuries are complex phenomena with multifactorial geneses, and they are now scientifically addressed with interdisciplinary approaches. Andersson [2] described how Heinrich in his DOMINO model viewed in 1931 the causal mechanism of accident and injury as a sequence of time-ordered interactions between the environment, human factors, and the hazard in question. Andersson also described another very similar framework, the so-called epidemiological model, proposed by Gordon in 1949. Heinrich’s background was industrial and so was his terminology. In medicine and epidemiology, the corresponding concepts are HOST → HUMAN, AGENT → HAZARD, ENVIRONMENT → ENVIRONMENT.

Andersson [2] further mentioned that Dr. William Haddon advocated in 1980 epidemiology as a method of analyzing injury. Haddon tailored a specific model for epidemiological research on accidents and injuries just by cross-tabulating the trichotomy of host–agent–environment with the dimension of time, divided into pre-accident, accident, and post-accident phases. The result was a two-dimensional information matrix with nine cells. The idea of the matrix was both analytical and preventive. The solution was first described by Gibson in 1961 (as cited in Andersson [2]), and later refined by Haddon. Energy is the chief agent of injury [2]. Heat results in burns, mechanical energy causes wounds, and fractures, and chemical energy manifests itself in corrosions, poisonings, etc. A third dimension has now been explored in the Haddon matrix by incorporating the use of value criteria in the decision-making process [3]. The assessment can be done either quantitatively or qualitatively. Though this process is not easy, it has the potential to encourage a community group agency to consider

and articulate some factors as determinants in decision-making; they are effectiveness, cost, freedom, equity, stigmatization, performance, and feasibility [3].

## 2. CASE STUDY

The accident that was chosen for this case study had occurred at the site of a large construction company in India. Field data were collected with a questionnaire by one of the co-authors. They were then collated and organized to facilitate analysis of the events. Based on the field data, fish bone structures (Figures 1 and 2) were constructed and eventually two-tier Haddon matrices (Tables 1 and 2) were organized, one at problem analysis level, and the other at accident prevention strategy level. The actual accident can be most effectively visualized with the help of the sketches provided in Figure 3.

The main objective of the construction operation was transportation of  $3 \times 1.5$  m metallic plates from a store room to the site where construction work was going on. The road, by which this plate was being transported, was also used as a public thoroughfare. Hence there was always a space constraint.

This operation involved a crane to transport the metallic plates, a crane operator, and two individuals, who assisted in the transportation of the plate as shown in Figure 3. Another important fact was that the crane operator was unable to see the individual (the victim in the sketch), who was holding the plate directly in front of the crane.

During one such transportation operation, the individual (the victim) accidentally came into contact with a wheel of the crane and suffered a fracture. Although he was immediately taken to hospital, eventually he died. What does this imply? Is the operation or process safe at all? What procedural modifications can be introduced in order to make the operation safe?

In order to answer those questions, and to make the operation safer, a cybernetic approach was adopted to effect operational control.

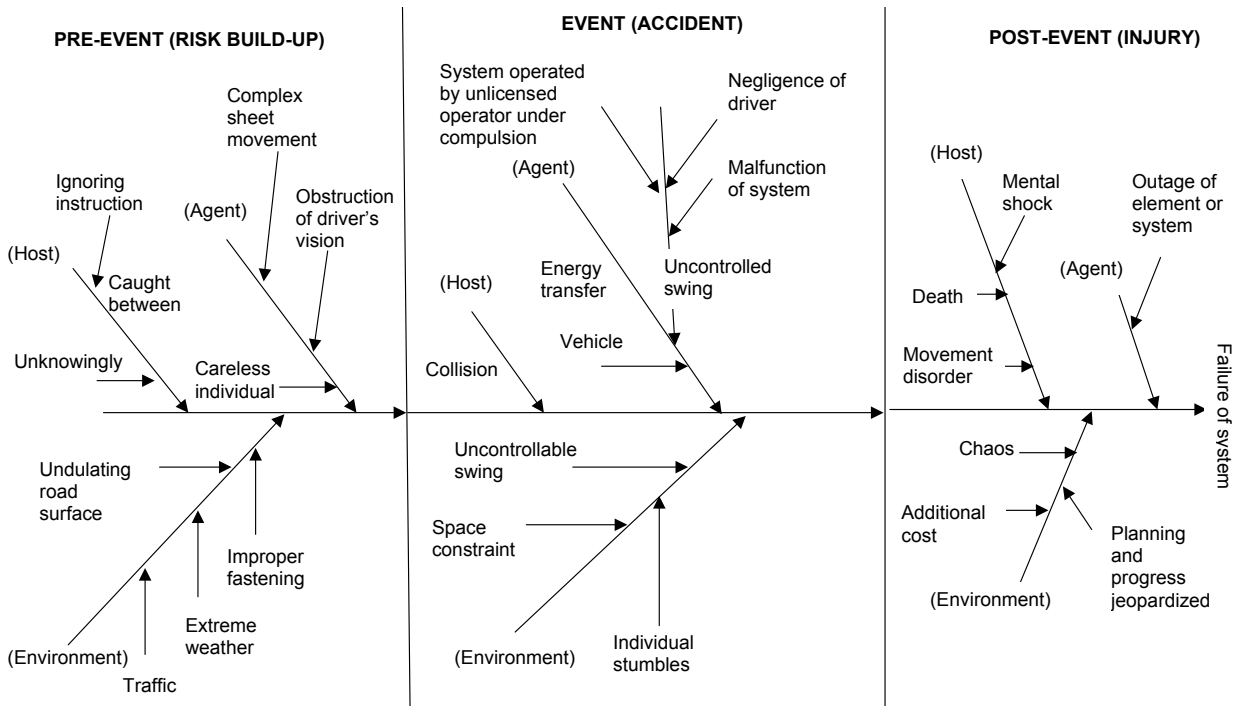

Figure 1. Fish bone diagram for an analysis of an accident problem.

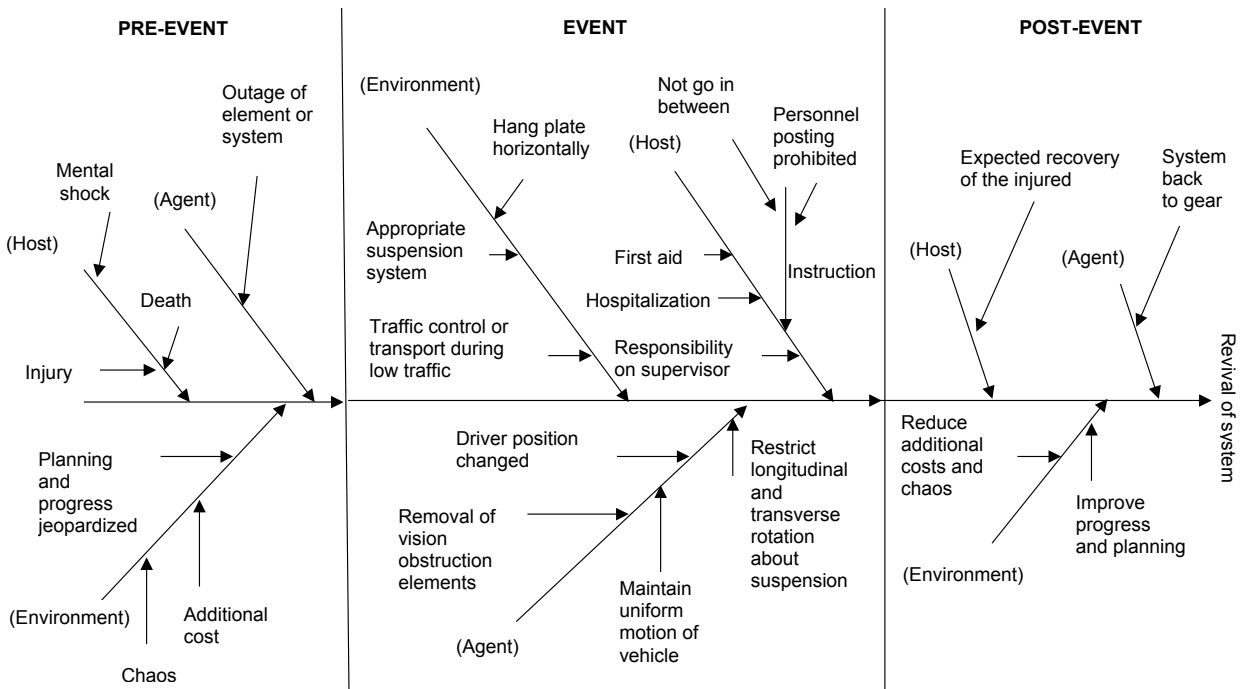

Figure 2. Fish bone diagram for preventive measures against an accident.

TABLE 1. Haddon Matrix Representing an Analysis of an Accident Problem

Parameters	Pre-Event (Risk Build-Up)	Event (Accident)	Post-Event (Injury)
Host	An individual comes in between the sheet and the crane (A1) · unknowingly (A1a) · ignoring instructions, if there were any (A1b)	The individual comes in contact with the wheels (B1)	<ul style="list-style-type: none"> <li>• Mental shock (C1)</li> <li>• Movement disorders (fractures) (C2)</li> <li>• Death (C3)</li> </ul>
Agent	<ul style="list-style-type: none"> <li>• The driver cannot see the individual (D1)</li> <li>• The sheet has complex motions (random direction of movement) because it is hung by a flexible chord (D2)</li> <li>• The individual at the front edge of the sheet is inattentive or negligent (D3)</li> </ul>	<ul style="list-style-type: none"> <li>• Mechanical energy transferred by the vehicle (E1)</li> <li>• The uncontrolled swing of the sheet also contributes to energy (E2)</li> </ul>	Driver suffers from guilt or uncertainty (F1)
Environment	<ul style="list-style-type: none"> <li>• There are undulations in the operation zone (G1)</li> <li>• The sheet is not fastened properly (G2)</li> <li>• There is traffic in side lanes (G3)</li> <li>• Weather conditions are extreme (G4)</li> </ul>	<ul style="list-style-type: none"> <li>• The individual stumbles (H1)</li> <li>• The sheet slips from the anchor (H2)</li> <li>• There is a space constraint (H3)</li> </ul>	<ul style="list-style-type: none"> <li>• Chaos ensues (I1)</li> <li>• Progress and planning is jeopardized (I2)</li> <li>• Additional cost is incurred (I3)</li> </ul>

Notes. A1, B1,C1, etc.—variables.

TABLE 2. Haddon Matrix Representing Preventive Measures

Parameters	Pre-Event (Risk Reduction)	Event (Prevention)	Post-Event (Injury Minimization)
Host	<ul style="list-style-type: none"> <li>• There are strict instructions not to go in between the sheet and the crane (A2)</li> <li>• The supervisor is responsible (A3)</li> </ul>	Individuals should move carefully (B2)	<ul style="list-style-type: none"> <li>• First aid is administered immediately (C4)</li> <li>• The individual is taken to hospital (C5)</li> <li>• Counseling is provided (C6)</li> </ul>
Agent	<ul style="list-style-type: none"> <li>• Elements causing vision obstruction should be removed or the driver's relative position should be changed (D4)</li> <li>• Longitudinal and transverse swing or rotation about the suspension should be restricted (D5)</li> </ul>	<ul style="list-style-type: none"> <li>• The vehicle should have uniform motion as far as possible (E3)</li> <li>• Random motion of the plate about the point of suspension should be arrested (E4)</li> </ul>	Confidence in the driver is built through counseling and training (F2)
Environment	<ul style="list-style-type: none"> <li>• The sheet should be hung horizontally instead of vertically (G5)</li> <li>• There should be an appropriate suspension system (G6)</li> <li>• Traffic should be controlled; transportation should take place at night or when traffic is light (G7)</li> </ul>	Preventive management should be deployed (H4)	Safe working practices and environment are ensured (I4)

Notes. A1, B1,C1, etc.—variables.

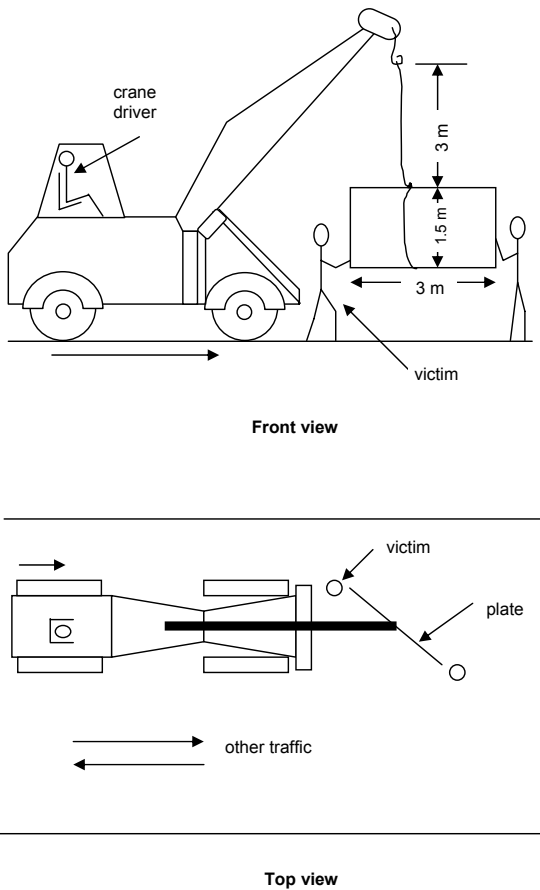

**Figure 3. Sketch of the case study—an accident at a construction site.**

### 3. Cybernetic Analysis of the Case Study

The concept of cybernetics was first introduced by Wiener [4]. A self-governing system survives only when its principal parameters maintain their values within certain preset limits. Ashby called them “essential variables”, because they played a critical role in any system’s survival [5]. Any variable going beyond its critical thresholds may develop an acutely unbearable condition. Control for regulation plays a role here [6].

Control is the central theme of cybernetics. The control process is goal-oriented. It operates through a time cyclic reactive structure, which consists in a chain of activity cycling upon itself recurrently. Depending upon its intended control function, the reactive cycle falls into two categories: (a) when the control objective is to maintain stability and balance within given limits, the reactive structure constitutes a negative

feedback cycle; or (b) when the aim is to bring about cumulative change, i.e., continuous growth or decline, the structure constitutes a positive feedback cycle. These negative and positive feedback cycles together assist in attaining the goals of regulation in a self-governing system [6].

Based on an analysis of the Haddon matrix, different variables of the system are identified in Tables 1 and 2 and are abbreviated in alphanumeric terms for visualization in the operating cycles (Figures 4 and 5).

From the multicycle structure representing the case study, the entire system can be represented individually using six positive and five negative feedback cycles (Figures 4 and 5, respectively), which are identified as follows.

- I (+): A1–B1–C2–A1;
- II (+): D1–E1–F1–C1–D1;
- III (+): D2–E2–F1–D2;
- IV (+): G1–G2–G3–G1;
- V (+): G1–H1–I1–G1;
- VI (+): G4–G2–H2–E2–C2–C3–I1–I2–I3–G2;
- I (–): A3–A2–B2–A3;
- II (–): A3–G6–G5–G7–B2–A3;
- III (–): D4–E3–F2–H4–I4–D4;
- IV (–): A3–H4–B2–C4–C6–A3;
- V (–): A3–G6–G5–D5–E4–H4–I4–A3.

#### 3.1. Salient Variables

Each variable in the multicycle structure of a complex problem receives a number of links from and emits a number of links to other variables. The total number of such links associated with a variable represents its relative salience in a system structure. Hence, the variables with the largest number of such links are the most salient. These variables stand at the intersection of several cycles and their changing values represent the cumulative outcome of the interaction process of these cycles. Therefore a set of such salient variables is sufficient to depict the changing state of a problem system [6].

The salient variables [6] for any system can be outlined as salience mass of the variable ( $X$ ) = sum of incoming links + sum of outgoing links:  $SM(X) = \sum IX + \sum OX$ . The salience mass of the

variables presented in Figures 4 and 5 is shown in Tables 3 and 4, respectively.

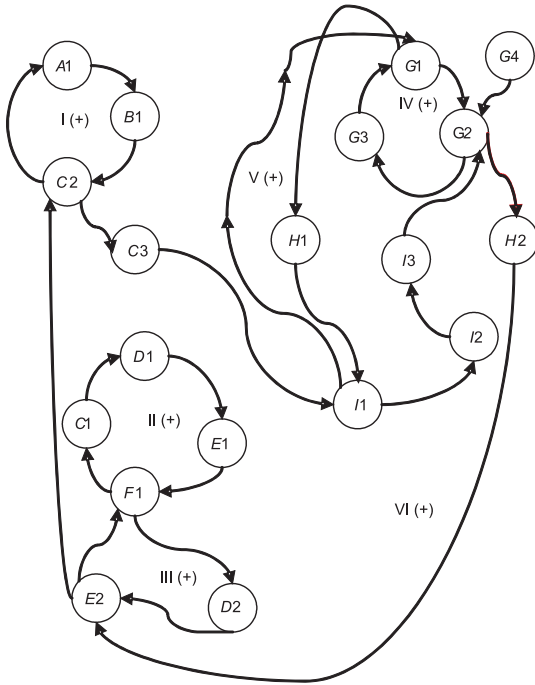

Figure 4. Cycle structure with positive feedback loops only. Notes. A1, B1, C1, etc.—variables.

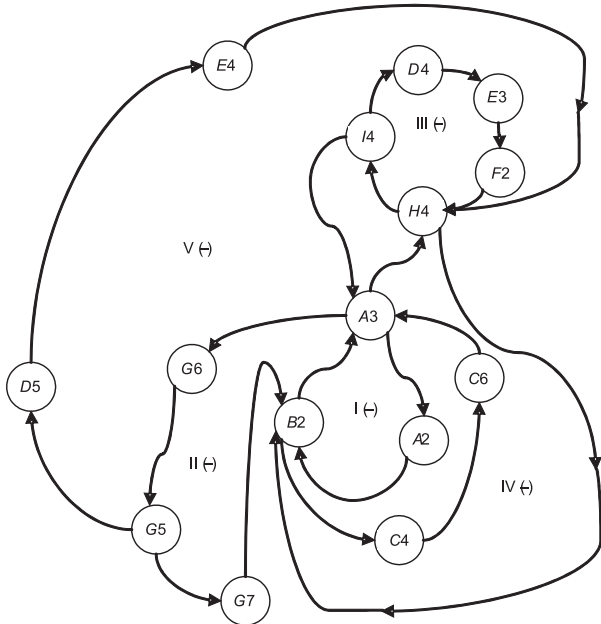

Figure 5. Cycle structure with negative feedback loops only. Notes. A1, B1, C1, etc.—variables.

TABLE 3. Salience Mass (SM) (Positive Feedback Cycle)

Variable (X)	$\sum IX$	$\sum OX$	$\frac{SM}{(\sum IX + \sum OX)}$
A1	1	1	2
B1	1	1	2
C1	1	1	2
C2	2	2	4
C3	1	1	2
D1	1	1	2
D2	1	1	2
E1	1	1	2
E2	2	2	4
F1	2	2	4
G1	2	2	4
G2	3	2	5
G3	1	1	2
G4	0	1	1
H1	1	1	2
H2	1	1	2
I1	2	2	4
I2	1	1	2
I3	1	1	2

Notes. IX—incoming links, OX—outgoing links.

TABLE 4. Salience Mass (SM) (Negative Feedback Cycle)

Variable (X)	$\sum IX$	$\sum OX$	$\frac{SM}{(\sum IX + \sum OX)}$
A2	1	1	2
A3	3	3	6
B2	3	2	5
C4	1	1	2
C6	1	1	2
D4	1	1	2
D5	1	1	2
E3	1	1	2
E4	1	1	2
F2	1	1	2
G5	1	2	3
G6	1	1	2
G7	1	1	2
H4	3	2	5
I4	1	2	3

Notes. IX—incoming links, OX—outgoing links.

### 3.2. Control Interaction of Variables

The incoming and outgoing links of variables reveal some interesting control properties of a system. The set of output links [OX] of a variable X shows the variables affected by the control action of X. The set of input links [IX] of the same variable indicates the variables controlling X. On analyzing together the sets [OX] and [IX], variables common to both these sets are detected.

Such variables are those controlled by  $X$ , and which in turn control  $Y$ ; they show the interaction of  $X$  and  $Y$ , the intersection set of  $[OX]$  and  $[IY]$ , i.e.,  $[OX \cap IY]$ , and they represent the common variables, i.e., those affected by  $X$ , and which in turn affect  $Y$ . If this interaction set is divided by the set  $[IY]$ , then it indicates the proportion of the variables in  $[IY]$  that are controlled by  $X$ . Symbolically,  $CI(OX, IY) = [OX \cap IY]/[IY]$ , where  $CI$  is the control interaction measure of variable  $X$  and  $Y$ , the numerator on the right-hand side is the cardinality of the intersection set of  $[OX]$  and  $[IY]$ , and the denominator on the right-hand side is the cardinality of set  $[IY]$  [6]. The value of this expression is zero if  $[IY]$  is zero. The control interaction matrix is significant as it gives guidance towards system regulation.

As a negative feedback cycle maintains stability and balance, while a positive feedback cycle leads to either continuous growth or decline, the entire system can be represented by a combined multicycle structure (Figure 6). Table 5 shows the corresponding control interaction matrix.

On the basis of the multicycle structure representing the case study, the entire system can

be represented using six positive and six negative feedback cycles, which are identified as follows.

- I (+): A1–B1–C2–A1;
- II (-): A1–A3–A2–B2–A1;
- III (-): B1–C2–C4–C6–I4–B1;
- IV (+): D1–E1–C1–F1–D1;
- V (-): D1–D4–E3–H4–F2–I4–D1;
- VI (-): E2–E1–A3–D5–F2–E3–E2;
- VII (+): D2–E2–D3–F1–D2;
- VIII (-): D3–D2–E2–G6–G5–D5–D3;
- IX (+): H4–D4–D5–G5–E4–G6–F2–I4–H4;
- X (+): G4–G2–H2–E2–C2–I1–I2–I3–G2;
- XI (+): G4–G1–G2–E2–H2–I2–F1–G1;
- XII (-): H4–A3–I4–G2–H2–G6–G5–D5–B2–H4.

### 3.3. Interpretations

In the control interaction matrix (Table 5), the numbers represent the relative importance of control interaction between the variables concerned. Also, the row entries show the variables that have to be regulated in conjunction with one another, without inconsistency and contradiction among themselves.

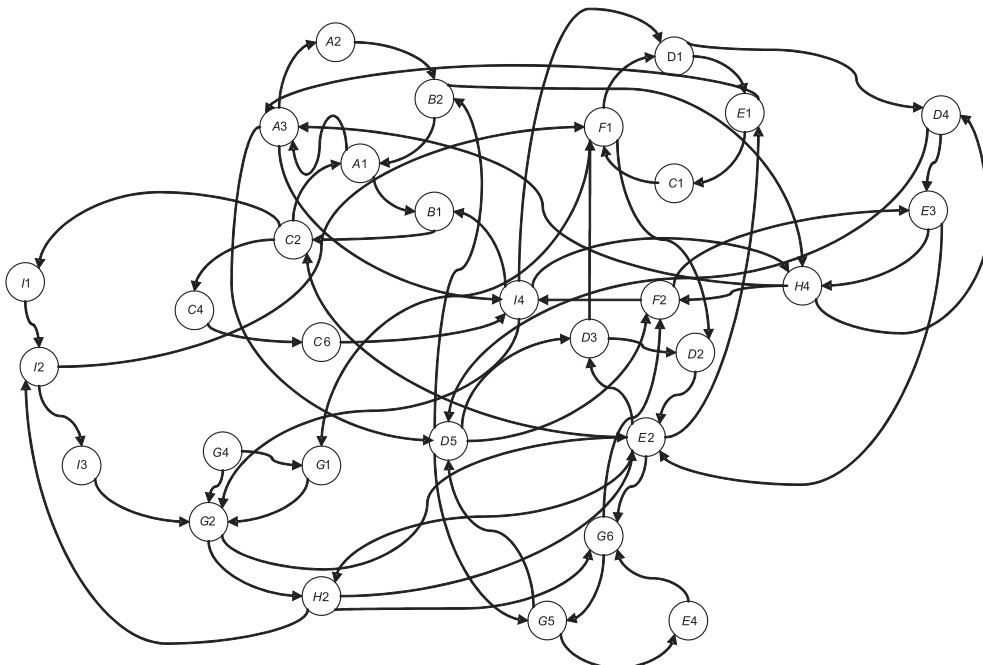

Figure 6. Multicycle structure representing the case study—an accident at a construction site. Notes. A1, B1, C1, etc.—variables.

For instance, row E2 (Figure 7) may be interpreted as follows. Damage due to an uncontrolled swing of the sheet (E2) cannot be checked if

1. accidental entry in-between the sheet and the crane is not prevented by rules of procedure (A1);
2. this is not a mandatory responsibility of the supervisor (A3);
3. mental shocks are not calmed by awareness programs (C1);
4. immediate first aid is not provided (C4);
5. random motion of the sheet hung vertically by a flexible chord is not arrested technically (D2);

**TABLE 5. Control Interaction Matrix of the Accident Problem (Derived From Figure 6)—Causes of Failure and Effects of Control Measures.** Notes. A1, B1, C1, etc.—variables.

	A1	A2	A3	B1	B2	C1	C2	C4	C6	D1	D2	D3	D4	D5	E1	E2	E3	E4	G1	G2	G4	G5	G6	H2	H4	I1	I2	I3	I4	F1	F2		
A1	0	1	0	0	0	0	1/2	0	0	0	0	0	0	0	1/3	0	0	0	0	0	0	0	0	0	0	0	0	0	0	1/3	0	0	
A2	1/2	0	0	0	0	0	0	0	0	0	0	0	0	0	0	0	0	0	0	0	0	0	0	0	1/3	0	0	0	0	0	0	0	
A3	0	0	0	1/2	2	0	0	0	0	1/2	0	1/2	0	0	0	0	0	0	1/4	0	1/2	0	0	1/3	0	0	0	0	0	0	1/3	0	
B1	1/2	0	0	0	0	0	0	1	0	0	0	0	0	0	0	0	0	0	0	0	0	0	0	0	0	1	0	0	0	0	0		
B2	0	0	2/3	1/2	0	0	0	0	0	0	0	1/2	0	0	0	0	0	0	0	0	0	0	0	0	0	0	0	0	0	0	1/3	0	
C1	0	0	0	0	0	0	0	0	0	1/2	1/2	0	0	0	0	0	0	1/2	0	0	0	0	0	0	0	0	0	0	0	0	0	0	
C2	0	0	1/3	1/2	0	0	0	0	1	0	0	0	0	0	0	0	0	0	0	0	0	0	0	0	0	0	1/2	0	0	0	0		
C4	0	0	0	0	0	0	0	0	0	0	0	0	0	0	0	0	0	0	0	0	0	0	0	0	0	0	0	0	1/3	0	0		
C6	0	0	0	1/2	0	0	0	0	0	1/2	0	0	0	0	0	0	0	0	1/4	0	0	0	0	1/3	0	0	0	0	0	0	0	0	
D1	0	0	1/3	0	0	1	0	0	0	0	0	0	0	0	0	0	1/2	0	0	0	0	0	0	0	0	0	0	0	0	0	0	0	
D2	0	0	0	0	0	0	1/2	0	0	0	0	1/2	0	0	1/2	0	0	0	0	0	0	0	1/3	1/2	0	0	0	0	0	0	0	0	
D3	0	0	0	0	0	0	0	0	0	1/2	1/2	0	0	0	0	1/4	0	0	1/2	0	0	0	0	0	0	0	0	0	0	0	0	0	0
D4	0	0	0	0	1/2	0	0	0	0	0	0	1/2	0	0	0	1/4	0	0	0	0	0	1/2	0	0	1/3	0	0	0	0	0	0	1/3	0
D5	1/2	0	0	0	0	0	0	0	0	0	1/2	0	0	1/3	0	0	1/2	1	0	0	0	0	0	0	1/3	0	0	0	1/3	1/3	0	0	
E1	0	1	0	0	0	0	0	0	0	0	0	0	0	1/3	0	0	0	0	0	0	0	0	0	0	0	0	0	0	1/3	1/3	0	0	
E2	1/2	0	1/3	0	0	1	0	1	0	0	1/2	0	0	0	0	0	0	0	0	0	0	1/2	1/3	0	0	1	1/2	0	0	1/3	1/3	0	
E3	0	0	1/3	0	0	0	1/2	0	0	0	0	1/2	1/2	0	1/2	0	0	0	0	0	0	0	1/3	1/2	0	0	0	0	0	0	0	1/3	0
E4	0	0	0	0	0	0	0	0	0	0	0	0	0	0	0	0	0	0	0	0	0	1/2	0	0	0	0	0	0	0	0	0	1/3	0
G1	0	0	0	0	0	0	0	0	0	0	0	0	0	0	0	1/4	0	0	0	0	0	0	0	1/2	0	0	0	0	0	0	0	0	0
G2	0	0	0	0	0	0	1/2	0	0	0	0	1/2	0	0	1/2	1/4	0	0	0	0	0	0	2/3	1/2	0	0	1/2	0	0	0	0	0	0
G4	0	0	0	0	0	0	0	0	0	0	0	0	0	0	0	1/4	0	0	0	1/4	0	0	0	1/2	0	0	0	0	0	0	0	0	0
G5	0	0	0	0	1/2	0	0	0	0	0	0	1/2	0	0	0	0	0	0	0	0	0	1/2	1/3	0	0	0	0	0	0	0	0	1/3	0
G6	0	0	0	0	0	0	0	0	0	0	0	0	0	1/3	0	0	1/2	1	0	0	0	0	0	0	0	0	0	0	0	1/3	0	0	
H2	0	0	0	0	0	0	0	0	0	0	0	0	0	0	1/2	0	0	0	0	0	0	1/2	1/3	1/2	0	0	0	0	1	0	1/3	1/3	
H4	0	1	0	0	0	0	0	0	0	0	0	0	0	2/3	0	0	1	0	0	0	0	0	0	0	0	0	0	0	0	2/3	0	0	
I1	0	0	0	0	0	0	0	0	0	0	0	0	0	0	0	0	0	0	0	0	0	0	0	0	0	0	0	0	1	0	1/3	0	
I2	0	0	0	0	0	0	0	0	0	1/2	1/2	0	0	0	0	0	0	0	1/2	1/4	0	0	0	0	0	0	0	0	0	0	0	0	0
I3	0	0	0	0	0	0	0	0	0	0	0	0	0	0	0	1/4	0	0	0	0	0	0	0	1/2	0	0	0	0	0	0	0	0	0
I4	0	0	1/3	0	0	0	1/2	0	0	0	0	0	1	0	1/2	1/4	0	0	0	0	0	0	0	1/2	0	0	0	0	0	0	0	1/3	0
F1	0	0	0	0	0	0	0	0	0	0	0	0	1/2	0	1/2	1/4	0	0	0	1/4	0	0	0	0	0	0	0	0	0	0	0	0	0
F2	0	0	0	1/2	0	0	0	0	1/2	0	0	0	0	0	0	1/4	0	0	0	1/4	0	0	0	2/3	0	0	0	0	0	0	0	0	0



$$\left| \begin{array}{cccccccccccc} A1 & A3 & C1 & C4 & D2 & G5 & G6 & I1 & I2 & F1 & F2 \\ \frac{1}{2} & \frac{1}{3} & 1 & 1 & \frac{1}{2} & \frac{1}{2} & \frac{1}{3} & 1 & \frac{1}{2} & \frac{1}{3} & \frac{1}{3} \end{array} \right| \rightarrow E2 \text{ (Row } E2)$$

$$\left| \begin{array}{ccccccc} E1 & G5 & G6 & H2 & I3 & F1 & F2 \\ \frac{1}{2} & \frac{1}{2} & \frac{1}{3} & \frac{1}{2} & 1 & \frac{1}{3} & \frac{1}{3} \end{array} \right| \rightarrow H2 \text{ (Row } H2)$$

$$E2 \rightarrow \begin{array}{c} \text{Column } E2 \\ \left| \begin{array}{c} D3 \quad \frac{1}{4} \\ D4 \quad \frac{1}{4} \\ G1 \quad \frac{1}{4} \\ G2 \quad \frac{1}{4} \\ G4 \quad \frac{1}{4} \\ I3 \quad \frac{1}{4} \\ I4 \quad \frac{1}{4} \\ F1 \quad \frac{1}{4} \\ F2 \quad \frac{1}{4} \end{array} \right| \end{array}$$

$$F1 \rightarrow \begin{array}{c} \text{Column } F1 \\ \left| \begin{array}{c} D5 \quad \frac{1}{3} \\ E1 \quad \frac{1}{3} \\ E2 \quad \frac{1}{3} \\ H2 \quad \frac{1}{3} \\ I1 \quad \frac{1}{3} \end{array} \right| \end{array}$$

**Figure 7. Interpretation of salient rows and columns of the control interaction matrix. Notes.** A1, B1, C1, etc.—variables.

- 6. the driver suffers from uncertainty (F1);
- 7. the driver is not given adequate training (F2);
- 8. the sheet is not hung horizontally instead of vertically (G5);
- 9. there is no appropriate suspension system (G6);
- 10. there is chaos (I1); and
- 11. progress and planning are jeopardized (I2).

Row H2 (Figure 7) may be interpreted as follows. The slippage of the sheet (H2) from the anchor can be checked if

- 1. transfer of mechanical energy by the vehicle to the sheet is arrested (E1);
- 2. the driver does not suffer from uncertainty (F1);
- 3. the driver is given adequate training (F2);
- 4. the sheet is hung horizontally instead of vertically (G5);
- 5. the suspension system is appropriate (G6);

- 6. the sheet is correctly anchored (H2); and
- 7. additional expenditure is sanctioned to implement safety measures (I3).

Column F1 (Figure 7) may be interpreted as follows. If the crane operator suffers from guilt or uncertainty (F1) (due to lack of adequate professional training), then

- 1. he may fail to restrict the swing or the rotation of sheets about the suspension even if arrangement to do so is provided (D5);
- 2. he may fail to check the transfer of mechanical energy by the vehicle to the suspended sheets (E1);
- 3. he may fail to control the swing of the sheet that contributes to energy (E2);
- 4. he may not notice the possible slippage of sheets (H2); and
- 5. chaos can ensue (I1).

Column E2 (Figure 7) may be interpreted as follows. The uncontrolled swing of the sheet (E2) that contributes to energy can be checked if

- 1. the individual at the front edge of the sheet is attentive all the time (D3);
- 2. there are no obstructions in the view path of the driver (D4);
- 3. the driver does not suffer from guilt or uncertainty (F1);
- 4. the driver is adequately trained (F2);
- 5. there are no undulations in the operation zone (G1);
- 6. the sheet is properly fastened (G2);
- 7. the weather conditions are not unfavorable (G4);
- 8. additional expenditure is sanctioned to implement safety measures (I3); and
- 9. safe working practices and environment are ensured (I4).

**3.4. Control Responsiveness (CR) and Controllability Salience (CS) of Variables**

The variables in a system differ in their responsiveness to control. This responsiveness is indicated by the ratio of the variables affected by a variable to those affecting it. Symbolically, CR of a variable X is  $(CR X) = [OX]/[IX]$  [6].  $CR(X)$  of 3 means that X affects three variables against one variable affecting it. By multiplying the CR index of X ( $CR X$ ) by its salience mass ( $\sum OX + \sum IX$ ), the CS value of X ( $CS X$ ) is obtained, i.e.,  $(CS X) = (CR X) (\sum OX + \sum IX)$  [6].

Variables with high CS mean that their regulatory impact in imposing control in the system is very high and therefore effective, efficient, and economic as well.

The concept of CR and CS may be illustrated with reference to the salient variables of the case study as follows,  $CS E2 = 11.25$ ,  $CS D5 = 9.33$ ,  $CS I4 = 9.33$ ,  $CS C2 = 7.5$ ,  $CS H2 = 7.5$ , and  $CS F1 = 6$ . Therefore out of the 31 variables, E2, D5, I4, C2, H2, and F1 are the most important variables because of their salience mass and CR values (Table 6). Thus, the regulatory of their control in the system is the highest.

**3.5. Reference Values of System Variables**

Some important questions ought to be answered now, e.g., how the changing behaviour of a problem system can be evaluated and how the impact of problem solving measures on the course of a problem’s regulation can be estimated [6].

**TABLE 6. Salience Mass (SM), Control Responsiveness (CR), and Controllability Salience (CS) of the Accident Problem**

Variable (X)	$\sum IX$	$\sum OX$	SM ( $\sum IX + \sum OX$ )	CR(X) (OX/IX)	CS(X) = ( $\sum IX + \sum OX$ )(OX/IX)
A1	2	2	4	1.00	4.00
A2	1	1	2	1.00	2.00
A3	3	3	6	1.00	6.00
B1	2	1	3	0.50	1.50
B2	2	2	4	1.00	4.00
C1	1	1	2	1.00	2.00
C2	2	3	5	1.50	7.50
C4	1	1	2	1.00	2.00
C6	1	1	2	1.00	2.00
D1	2	2	4	1.00	4.00
D2	2	1	3	0.50	1.50
D3	2	2	4	1.00	4.00
D4	2	2	4	1.00	4.00
D5	3	4	7	1.33	9.33
E1	2	2	4	1.00	4.00
E2	4	5	9	1.25	11.25
E3	2	2	4	1.00	4.00
E4	1	1	2	1.00	2.00
F1	3	3	6	1.00	6.00
F2	3	2	5	0.66	3.33
G1	2	1	3	0.50	1.50
G2	4	2	6	0.50	3.00
G4	0	2	2	NA	—
G5	2	2	4	1.00	4.00
G6	3	2	5	0.66	3.33
H2	2	3	5	1.50	7.50
H4	3	3	6	1.00	6.00
I1	1	1	2	1.00	2.00
I2	2	2	4	1.00	4.00
I3	1	1	2	1.00	2.00
I4	3	4	7	1.33	9.33

Notes. IX—incoming links, OX—outgoing links.

The succession of the states of variables in a system represents its course on a time scale. Each variable refers to an aspect of system regulation assessable in terms of a performance standard. The evaluation criterion is the relative closeness of the values of system variables to their corresponding reference values or a performance standard.

A preset value of performance standards reflects a problem solver's understanding of and judgment on what constitutes *perfect*, *acceptable*, *poor*, *very poor*, and *worst* performance of a variable. Accordingly, they also indicate the relative regulatedness ( $\lambda$ ) or viability of a variable along a dimension of system performance [6].

The regulatedness of a variable may range from 0 (*total disruption*) to 1 (*perfect regulation*). A mapping of the levels of regulatedness (Figure 8) onto the performance standards provides a schema for measuring the regulatedness of a system variable [6].

To illustrate the viability scale of the important variables involved in the case study, some of the variables are projected (Figure 8).

### 3.6. Hypothetical Situation

In an organization, the following information is available over a period of time.

1. There is 5% of slippage of sheets (scale 0.95),  $H2(\lambda) = 0.5$ ;
2. 80% of plates swing between stipulated limits (scale 0.1),  $E2(\lambda) = 0.62$ ;
3. 90% plates are properly arrested against swing or rotation (scale 0.95),  $D5(\lambda) = 0.75$ ;
4. There is a 5% chance of failure due to adoption of proper safe working practices (scale 0.05),  $I4(\lambda) = 0.75$ ;
5. There is some sympathy for the victim in the mind of the crane operator,  $F1(\lambda) = 0.8$ .

The system viability [6] of the events after the incident is

$$Z = (\sum \lambda_i) / 5 \text{ where, } i = 1, 2, \dots, 5;$$

$$Z = (0.5 + 0.62 + 0.75 + 0.75 + 0.8) / 5 = 0.684.$$

The viability state of 0.684 (between 0.5 and 0.75) indicates that the total system is in an

ineffective regulatedness state. Moreover there is scope for improvement by controlling the variables  $H2$ ,  $E2$ ,  $D5$ ,  $I4$ , and  $F1$ .

## 4. Advantages and Limitations of the Proposed Methodology

Accidents and injuries are complex phenomena with multifactorial geneses and therefore they need to be scientifically addressed with interdisciplinary approaches.

1. Any event has a probable cause and a consequent effect. The fish bone diagram, which is very useful in engineering system analysis, has therefore been very effectively used in this case.
2. Insight into cause and effect relations eases towards the construction of the Haddon matrix.
3. The Haddon matrix in activities involving risk acts as a potential tool for identifying the variables, viz., environment, human, hazard, accident, and injury, and mapping them into the epidemiological conceptions of host, agent, and environment in discrete time domains of pre-events, events, and post-events.
4. Haddon's concept has thus naturally led to this proposed concept of the two-tier Haddon matrix; one for analysis of the problem and the other for finding the solutions.

On the other hand, the cybernetic concept is the most generic, and therefore system independent, tool which helps to identify system variables, map the variables for their inter-relations and impose control for regulations of the system, and assess/monitor the effectiveness of control measures.

1. The most important advantage is that the variables responsible for poor functioning of the system are recognized, and proactive measures can be adopted to enhance the system viability.
2. It is possible to prioritize preventive actions on the basis of accident analysis.

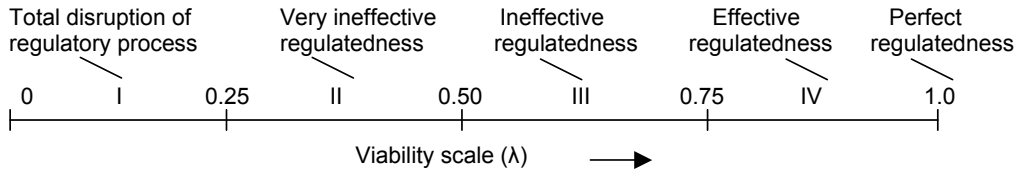

1. Variable  $F1$ : Uncertainty/guilty feeling in crane driver,  $F1(\lambda)$

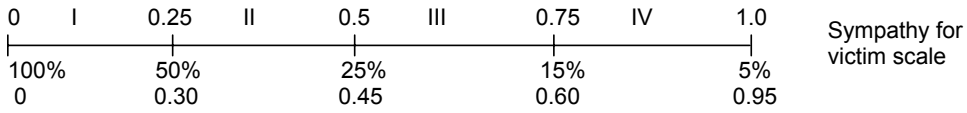

2. Variable  $H2$ : Slippage of sheet from anchor,  $H2(\lambda)$

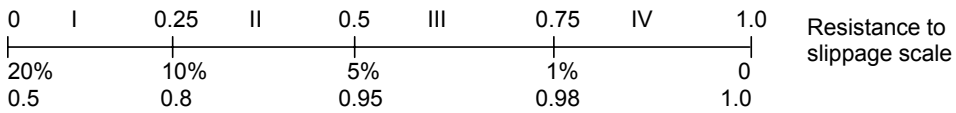

3. Variable  $D5$ : Restricting longitudinal and transverse swing or rotation,  $D5(\lambda)$

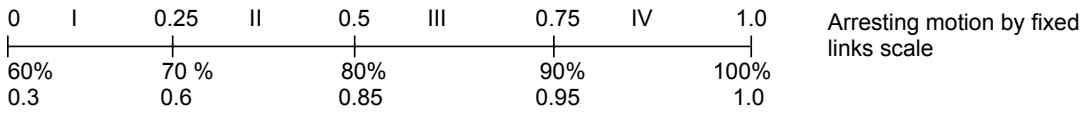

4. Variable  $I4$ : Ensure safe work practice and environment,  $I4(\lambda)$

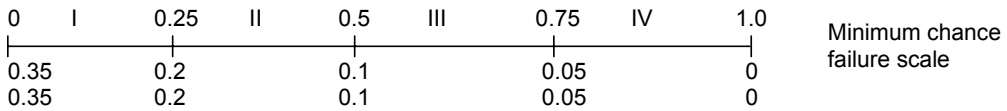

5. Variable  $E2$ : Swing of the sheet,  $E2(\lambda)$

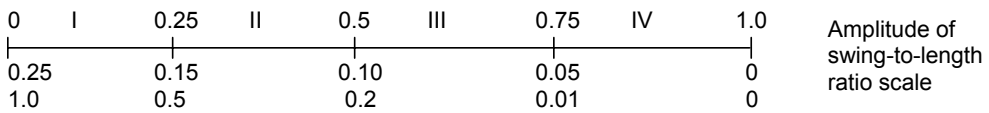

Figure 8. Viability scales for different variables of the accident problem. Notes.  $A1, B1, C1$ , etc.—variables.

3. However, the limitation is that the complexity of the approach increases very fast with the number of variables, which makes the management of the procedure in generating and identifying the variables, and interactions of the cycles very difficult, unless the system

is broken down into subsystems, or some computerization is adopted.

4. Further, identification of the operative cycles demands a rational thinking on part of the analyst.

## 5. CONCLUSION

This paper highlights the application of the Haddon matrix in the analysis of a case study of an accident in a large construction site. The Ishikawa (fish bone) diagram has been effectively used in constructing the two-tier Haddon matrix in analyzing the problem in three phases of its existence and prescribing preventive steps. The consistency in creating the two-tier Haddon matrix is examined through the more generic approach of cybernetics that helps to identify the most critical event variables. Thus effective operational control for regulatedness can be imposed proactively by monitoring and adjusting or regulating the states of salient system variables. The complete methodology offers assistance in attaining the goals of regulation in a self-governing system in general, and ensures safety especially in risk prone activities.

## REFERENCES

1. Roland EH, Moriarty B. System safety engineering and management. New York, NY, USA: Wiley; 1983.
2. Andersson R. Injury causation as a process. In: Mohan D, Andersson R, editors. Proceedings Introduction to Injury Control & Safety Promotion. 4th International Course on ICSP, organized by TRIPP (IIT, New Delhi), Karolinska Institute (Stockholm), SIDA (Sweden) and WHO. New Delhi, India: TRIPP, Indian Institute of Technology; p. 3, 7–8.
3. Runyan CW. Haddon matrix: introducing the third dimension. *Inj Prev.* 1998;4:302–7. Retrieved November 14, 2006, from: <http://ip.bmjournals.com/cgi/content/extract/4/4/302>
4. Weiner N. Cybernetics. Cambridge, MA, USA: MIT Press; 1948.
5. Ashby W R. An introduction to cybernetics. London, UK: Chapman & Hall; 1956.
6. Rastogi PN. An introduction to social and management cybernetics. New Delhi, India: East-West Press; 1979.